

 drizzle



merlin400

USER MANUAL

Learn about setup, extraction, maintenance, software updates, use of the app, and safety.

Find more information and video demonstrations at
www.drizzle.life



INDEX

1. Welcome to the world of home extraction	4	9.4 How to calculate the amount of carrier oil	23
2. Guide to this manual	5	9.5 List of Applications	23
2.1 Quick guide: Your first extraction.....	6	Raw oral drops (not decarbed)	24
3. Content of your box	8	Decarbed oral drops	24
4. Safety	10	Raw extract for edibles	24
5. The critical need-to-know	11	Extracts in oil vape pens	24
6. This is Merlin400	12	E-cigarettes	24
6.1 The 3 Chambers	12	Dab.....	24
6.1.1 IPA chamber	12	Enhanced herbs	24
6.1.2 Extraction chamber	13	Lotions	24
6.1.3 Distillation chamber	13	10. Startup: Getting your Merlin400 ready	25
6.2 User panel.....	14	11. Programs	25
6.2.1 Start button	15	11.1 Program 1: Make extract.....	26
6.2.2 Select button	15	11.1.1 Preparations	26
6.2.3 Pause button	15	Prepare the herbs.....	26
6.2.4 Reset (select + pause).....	15	Pack the herb tube.....	26
6.2.5 Indicator lights.....	16	Prepare the 3 chambers.....	27
7. Ingredients for extraction	16	11.1.2 Checklist before extraction.....	28
7.1 IPA, the extraction solvent	16	11.1.3 Start the extraction.....	28
7.1.1 Find the right IPA for Merlin400	17	11.1.4 During the program	28
7.2 Herbs.....	17	11.1.5 Finish the program	28
7.2.1 Cannabis and hemp plants	17	11.2 Program 2: Decarboxylate.....	29
7.2.2 Other plants.....	19	11.2.1 Preparations	29
8. How Merlin400 Works	21	11.2.2 Checklist before start.....	29
9. Using the extract	22	11.2.3 Start the decarboxylation	29
9.1 Decarboxylation	22	11.2.4 During the program	29
9.2 Why mix with a carrier?	22	11.2.5 Finishing the program.....	29
9.3 How to weigh your extract.....	23	11.3 Program 3: Heat and melt for mixing.....	30
		11.3.1 Preparations	30

11.3.2 Checklist before start.....	30	14.2.2 Link phone	44
11.3.3 Start the heating	30	14.3 Update software	44
11.3.4 Finishing the program.....	30	14.4 Applications only in app.....	45
11.4 Program 4: Distillation only.....	31	14.4.1 Extraction only	45
11.4.1 Preparations	31	14.4.2 Vent valves	46
11.4.3 Checklist before start.....	32	14.4.3 Clean pump	46
11.4.4 Start the distillation	32	14.4.4 Manual valve control	46
11.4.5 Finishing the program.....	32	14.5 Send machine log.....	46
12. Maintenance	33	15. Tips & tricks	47
12.1 Basic cleaning: After each run.....	33	15.1 Clean used IPA	47
12.1.1 Clean the herb tube and collection glass	33	15.2 Advanced uses	47
12.1.2 Disposal of the used herbs	33	15.2.1 Recover IPA from used herbs.....	48
12.1.3 Clean the extraction chamber	34	15.2.2 Add recovered IPA to increase the yield	48
12.1.4 Clean the distillation chamber		15.2.3 Multiple, cumulative extractions.....	49
and the elevator	34	16. Disposal of Merlin400.....	50
12.2 Extended cleaning: After every 10th run	34	16.1 Disassemble and recycle parts.....	50
12.3 When to change IPA.....	35	Electronics & motors.....	50
13. Errors and error codes	36	Plastic parts	50
13.1 How to deal with an error.....	36	Top and bottom plate.....	50
13.2 Reset Merlin400.....	36	Tubing	50
13.3 Error overview	37	16.2 Return to Drizzle	50
14. Merlin400 App.....	42		
14.1 Connect Merlin400 to			
internet and link with phone	42		
14.1.2 Connect to Merlin400s access point	42		
14.1.3 Configure Merlin400 to access			
the internet	43		
14.2 Link another phone to Merlin400.....	44		
14.2.1 Connect new phone to Merlin400.....	44		

1. WELCOME TO THE WORLD OF HOME EXTRACTION

Thank you, and congratulations on your new Merlin400 extraction unit!

We are proud of our Merlin400, the world's first automated plant oil extractor for home use. We hope that you will be happy with your purchase.

The Merlin400 is built and designed to give you the highest possible quality extraction and yield. It works as an easy 1-click operation extractor out of the box, but you can access more features and update the machine using the Merlin400 App.

This user guide will help you get the best possible experience from the machine, prevent potential dangers, and avoid damage to the device. Before using this machine the first time, you must read the safety and critical need-to-know sections. We strongly recommend that you read the manual to get the full benefit of your Merlin400.

The Merlin400 is a very advanced piece of equipment, and several steps of the extraction process can be customized. Modifying extraction parameters means that the Merlin400 can successfully extract ethereal oils from many different plants.

Most of our customers use our Merlin400 to extract cannabis oil. Therefore, the present manual is primarily focused on how to use the machine to produce high-quality cannabis oil extract. However, you will find a chapter in this manual that describes the use of the Merlin400 when extracting ethereal oils from non-cannabis plants. This chapter is merely meant as a start for you to experiment. Still, the detailed description in the manual for producing cannabis oil may guide you to use the Merlin400 to extract ethereal oils from other plants.

Please be aware that some cannabinoids are restricted by law or regulated as medicine in some countries. Check your local regulations before acquiring cannabis or hemp.

We hope you will enjoy this machine every bit as much as we did creating it for you!

2. GUIDE TO THIS MANUAL

This manual contains different types of information, including descriptions, step-by-step directions, and cannabis knowledge. It is divided into the following sections:

- * The basics are in the beginning: “Content of your box”, “Safety”, and “The critical need-to-know”.
- * “This is Merlin400” is a description of the physical appearance and the names of the Merlin400 components. The section “Ingredients for extraction” provides knowledge about the ingredients to use in Merlin400 (cannabis and IPA). And, in the section “How it works” the process is described.
- * The section “Using the extract” goes through different ways of using the output (raw extract) from Merlin400. Depending on which way you choose to apply cannabis, you can use one or more of the programs offered by Merlin400. This section provides the information to choose which programs to use.
- * Step-by-step directions on how to use and take care of Merlin400 are found in the sections “Programs”, “Maintenance”, and “Errors”, respectively.
- * The Merlin400 app is a valuable tool that you can either use right from the start or wait until later. The “Merlin400 App” section goes through the benefits and how you can use the app.
- * “Tips & tricks” gives step-by-step instructions on a number of more advanced uses. These require experience with the Merlin400 processes and programs. We recommend that you familiarize yourself with the automated processes before you use the advanced techniques in this section.
- * At the end of the manual, you find a section on “Disposal”.

Video demonstrations and updated information are also available at www.drizzle.life.

2.1 Quick guide: Your first extraction

This is a quick guide to the extraction process. We suggest that you use lower quality industrial hemp or cannabis for your first test extractions.

Familiarize yourself with your Merlin400 by reading the sections “4 Safety”, “5 The critical need-to-know” and “This is Merlin400”.

Make an extraction (quick guide)

1. Pack the herb tube carefully, as shown. Place the herb tube in the extraction chamber.
2. Check IPA level in the IPA chamber. Change or refill as needed (3-5 cm from the upper edge).
3. Put 2-3 glass beads in the collection glass. Place the glass on the heat bed. Close the elevator, so the glass is sealed against the gasket.
4. Use the select button to choose program 1 (indicator light no. 1). Press Start.
5. When the extraction has finished (2-3 hours), you have your raw extract ready to use in your preferred application.

For more detailed information on the quickest ways to make your first extract, you can check out the following sections of this manual:

1. Startup: Getting your Merlin400 ready (Section 10).
2. Program 1 - Make extract (Section 11.1).
3. Program 3 - Heat and melt for mixing (Section 11.3).
4. Cleaning (Section 12.1). How to clean and maintain Merlin400.

At the end of program 1, you will have the raw extract and you can find guidance on different ways to use the raw extract in “Using the extract” (Section 9). For your first application we suggest starting out with making the raw extract into non-decarbed drops by using program 3 to mix the extract with an edible oil.

After going through the above steps you have the extract, diluted with edible oil, in the pipette bottle, ready to use.

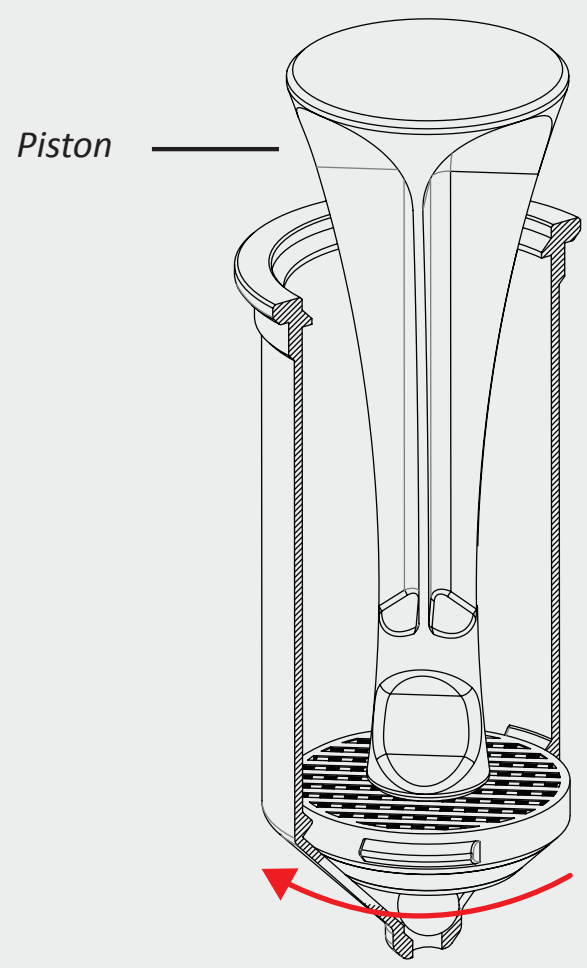
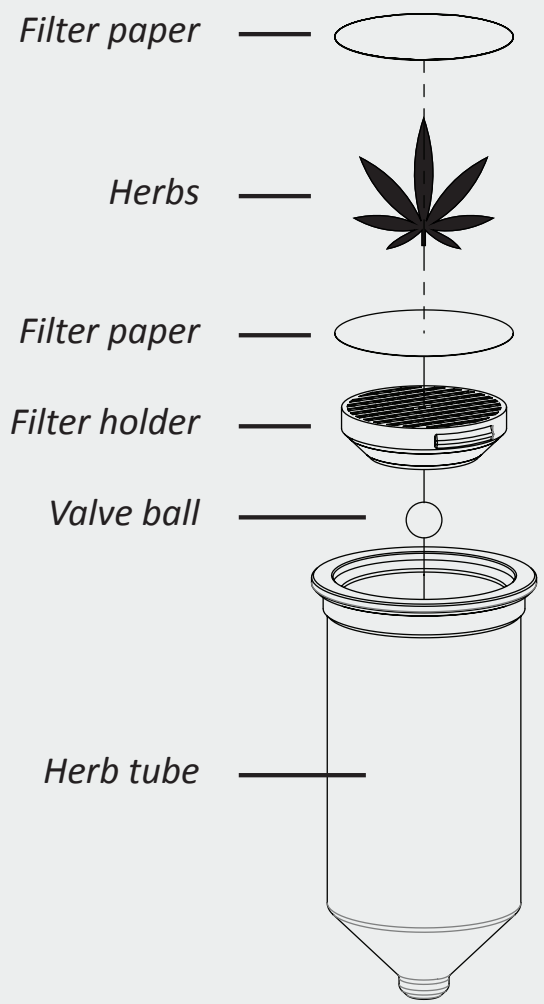

3. CONTENT OF YOUR BOX

Merlin400 comes with several accessories listed here. Spare parts and 99,9% IPA can be ordered through the Drizzle webshop at www.drizzle.life.

1. MERLIN400. The extractor unit. See detailed picture in the section “This is Merlin400”.
2. POWER CORD. 230 V cord to power Merlin400.
3. STARTER BAG. A bag of industrial hemp containing CBD for your first extraction.
Not included in all countries.
4. DRIZZLE IPA (isopropyl alcohol). When extracting with Merlin400 you should use the solvent IPA (min. 99,9%) of suitable quality. Caution: IPA is flammable. *Not included for all countries.*
5. HERB TUBE. The container where you pack the herbs you want to extract.
6. VALVE BALL. Use when packing the herb tube. The ball prevents dripping from and is placed in the bottom of the herb tube.
7. FILTER HOLDER. Use when packing the herb tube. The holder provides support for the lower filter paper and the herbs. It goes into the herb tube after the valve ball and is secured by using the back end of the piston.
8. FILTER PAPER. Use when packing the herb tube. You need two filter papers for each extraction. The filter papers are placed below and above the herbs in the herb tube, to keep plant material in place during extraction and prevent it from entering the inner channels of Merlin400.
9. PISTON. Use when packing the herb tube. One end of the piston is used to stomp the herbs together in the herb tube. The other end can be used to secure/loosen the filter holder in the herb tube.
10. FUNNEL. Use when packing the herb tube and filling the IPA chamber.
11. TUBE HOLDER. Use this support stand to keep the herb tube upright and handy, when the tube is not in the extraction chamber.
12. SYRINGE. Use the syringe to precisely measure the IPA you add to the IPA chamber. Use it also to remove excess IPA.
13. GLASS BEADS. Added to the collection glass to control the boiling during distillation.
14. COLLECTION GLASS. This is where the raw extract is collected.
15. PIPETTE BOTTLES. Use these to store and dispense raw drops or decarbed drops.
16. PIPETTE. To measure and transfer small amounts of liquid and oil.



4. SAFETY

Merlin400 is intended for indoor use, e.g., kitchens and non-professional use only. Any other use is considered improper and may result in personal injury or property damage. Drizzle is not responsible for damage caused by improper use.



Always observe the following guidelines to avoid injury due to improper use:

- ! Avoid ignition sources (smoking, lighters, etc.) around Merlin400.
- ! Always ensure air circulation around Merlin400.
- ! Only use 99.9% USP grade IPA (isopropyl alcohol) in Merlin400.
- ! If Merlin400 leaks IPA, unplug the power cord and dry off the IPA.
- ! Do not open the lids while Merlin400 is in operation.
- ! Regularly update your Merlin400 software (see the manual section 14.2).
- ! Merlin400 must be disconnected from the power supply when it is unattended.

Failure to comply with the guidelines above and extensive industrial use of the extractor will void the guarantee.

5. THE CRITICAL NEED-TO-KNOW

Here is a brief collection of the most important features that you need to know about your Merlin400. Not following these may void the warranty.

- * Make sure to pack the herb tube carefully according to instructions to avoid herbs being flushed into the machine and clogging the inner canals.
- * Make sure there is an airtight seal between the collection glass and the gasket when making extractions or distillations. If not, Merlin400 will not be able to start.
- * Clean Merlin400 after each use and more extensively after every 10th use. Do NOT use soap or dishwasher when cleaning Merlin400.
- * If you stop and reset Merlin400 during extraction and there is still IPA in the distillation chamber, you can run Program 4 (distillation only) to remove the IPA. Make sure there is enough room in the IPA chamber for the recaptured IPA so Merlin400 does not flood.
- * Using the Merlin400 App will allow you to follow the extraction process, operate the machine, and update it with the latest software.
- * Software updates. Merlin400 is more like a pc than a blender, meaning that it contains a quite advanced computer. To keep Merlin400 up to date, please make sure to update the software regularly. You find the instructions in section "14.2 Update software".

You will find much more valuable information on the following pages. Visit www.drizzle.life for more information and video demonstrations or contact customer support at support@drizzle.life.

6. THIS IS MERLIN400

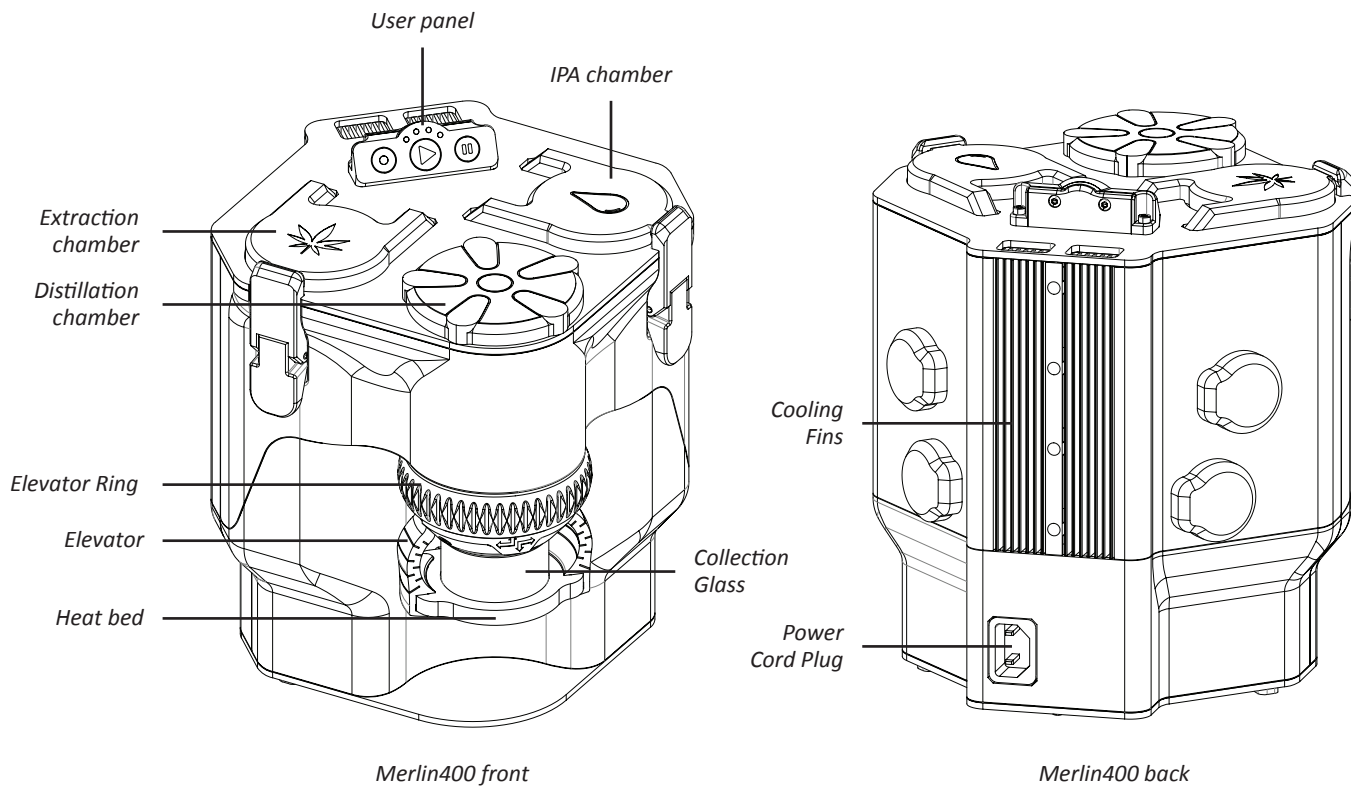

6.1 The 3 Chambers

Merlin400 consists of three main chambers:



6.1.1 IPA chamber

The IPA chamber holds the IPA (the solvent for extraction) and collects the IPA again after distillation.

6.1.2 Extraction chamber

The extraction chamber is where the extraction magic happens.
The main parts in the chamber, that you should know about, are:

- * The extraction chamber where the herb tube can be inserted.
- * The two gaskets ensure an airtight closure.

Herb tube

The herb tube is packed with starting material and inserted into the extraction chamber. See how to pack it in section “11.1.1 Pack the herb tube”.

6.1.3 Distillation chamber

The distillation chamber is where the distillation takes place, and the extract is obtained.

The distillation chamber consists of:

- * The lid, containing a gasket to ensure an airtight closure.
- * An opening to the elevator and the collection glass. Here is another gasket to ensure an airtight closure.
- * The elevator ring, the elevator, and the heat bed.
- * The collection glass is where the raw extract gets collected.

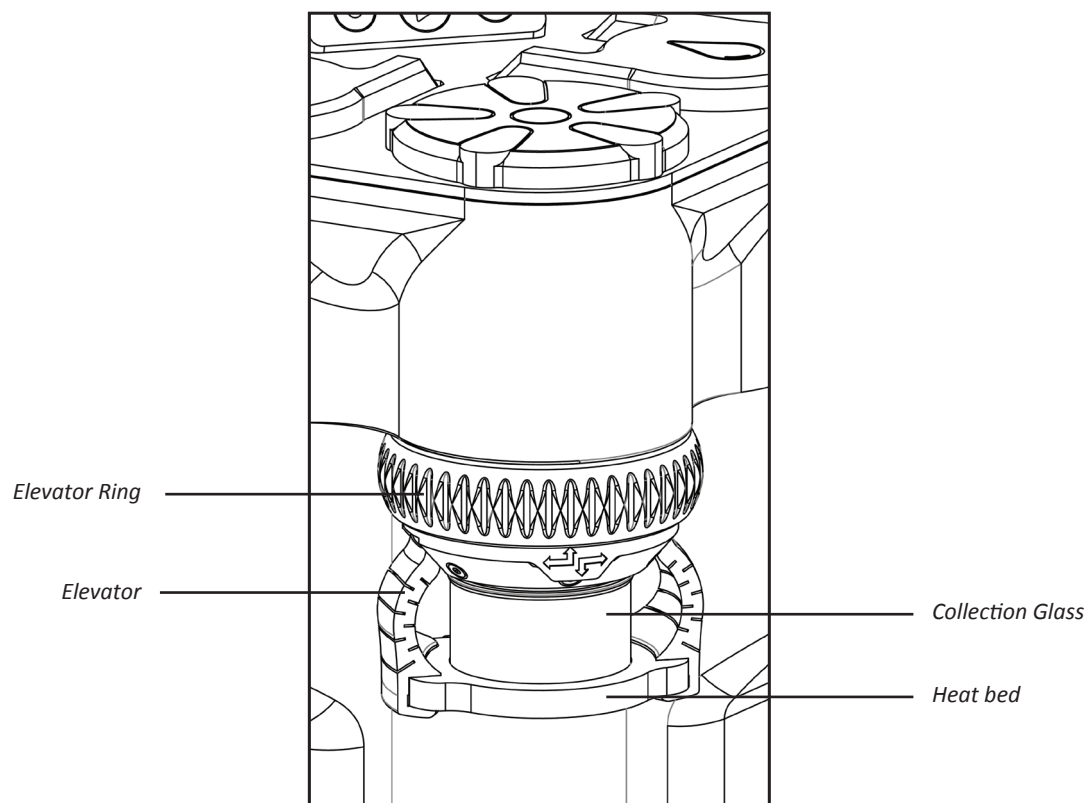

The distillation chamber

Elevator ring

Turn the elevator ring left (clockwise) to raise the elevator up or right (counter-clockwise) to lower it down, while holding the collection glass.

ATTENTION! Raising the elevator makes an airtight connection between the collection glass and the gasket. This requires a delicate touch: It has to be tight enough to stop air from entering the machine, but not too tight, which risks breakage. When the program has started, you can tighten it a bit more to ensure a tight fit between the heat bed and the collector glass. You will soon get the feeling for how much to turn the elevator ring.

When removing the collection glass, be careful not to lower the elevator ring too far down since you may dislodge the elevator.

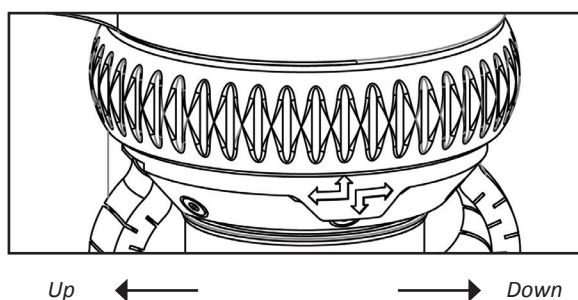

Elevator

The elevator is where the collection glass is placed on the heat bed and lifted to make an airtight connection to the distillation chamber.

Heat bed

The heat bed is the heating plate under the collection glass.

Collection glass

This is where the extract is collected. A light behind the collection glass automatically turns on when extraction or distillation is started. The light can be turned on/off by pressing start while the program is running.

6.2 User panel

The user panel has 3 buttons: select, start, and pause. These are used to select a program (select), start a program (start), and stop and reset a program (select + pause). Above the start button are four indicator lights, showing either the selected program or error codes.

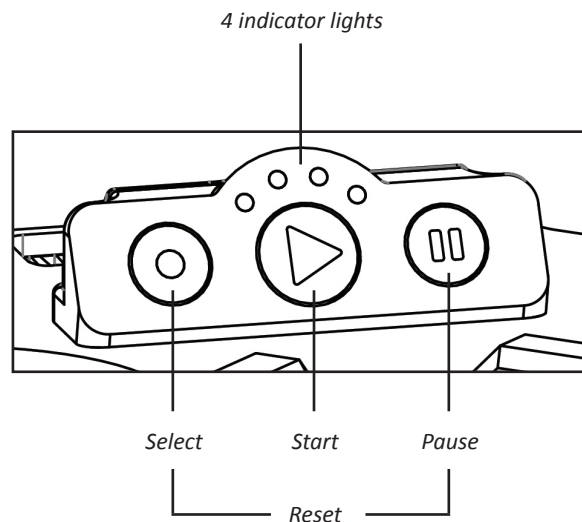

6.2.1 Start button

The start button has three purposes: To start a program, to turn the light behind the collection glass on and off during extraction, and to indicate the state of Merlin400.

The start button can be either red or green, blinking or constant.

Blinking green light: Running startup procedure or a program.

During the startup procedure this light will blink for approximately one minute while Merlin400 preps the machine to start.

Constant green light: Ready state. Merlin400 is ready to use.

Blinking red light (including blinking indicator lights): Merlin400 is canceling the current program and resetting (see below).

Constant red light: Error state. Merlin has encountered an error. The four indicator lights will show the error code. See section "13. Errors and error codes".

6.2.2 Select button

When Merlin400 is in the ready-state (the start button is constant green) you can click the select button to toggle the desired program. The corresponding indicator will light up.

6.2.3 Pause button

Click the pause button to pause an ongoing program. If you need to be away for a longer time, RESET Merlin400, unplug the power cord, and restart when you return.

6.2.4 Reset (select + pause)

To reset Merlin400, press select and pause simultaneously. The start button and the four indicator lights will blink for a few seconds. Then Merlin400 is reset. This function can also be used to exit a program before it has finished and exit from an error state.

6.2.5 Indicator lights

Above the start button are four indicator lights, showing either the selected program or error codes. They are numbered 1 to 4 from left to right:

If the start button is green, the indicator lights show the program that has been selected or is running. If the start button is red, Merlin has encountered an error. The four indicator lights will show the error code. See section “13. Errors and error codes”.

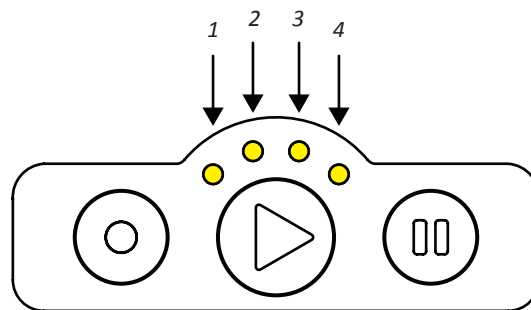

7. INGREDIENTS FOR EXTRACTION

To make an extraction with Merlin400, you need IPA and herbs (cannabis or other plants). This section tells you more about these ingredients.

7.1 IPA, the extraction solvent

Merlin400 is designed and optimized for IPA (isopropylalcohol, CAS-no.: 67-63-0).

It is recommended that you only use minimum 99,9% IPA in the Merlin400. Using other solvents apart from IPA is not recommended and will void the warranty.

Alcohols, including IPA, are toxic and highly flammable. Although the Merlin400 is a closed-loop system recycling 90-100% of the vaporized solvent and equipped with an alcohol sensor for added safety, you should always avoid spilling and pay close attention when handling highly flammable solvents.

The IPA provided by Drizzle is of a quality that can safely be used for extracting cannabinoids for consumption. After distillation, only trace amounts of IPA are left in the end product.

7.1.1 Find the right IPA for Merlin400

IPA is sold in different concentrations and different purities, and it is important that the IPA that is used in the Merlin400 is of an acceptable concentration and purity. For this reason, you will find below a short guide that may help you to find the IPA that is suitable for the Merlin400.

In the Merlin400, only IPA with a concentration of 99.9% should be used. IPAs with lower concentrations than 99.9% may adversely affect the Merlin400, void the warranty, and/or contain harmful substances.

There are several different purity qualities even for 99.9% IPA. The lowest purity is technical grade and IPA of this purity should not be used in the Merlin400.

The IPA recommended for use in the Merlin400 meets or exceeds purity requirements posed by the U.S. Pharmacopoeia (USP), the corresponding European Pharmacopoeia (EP or Ph. Eur.), or the British pharmacopoeia (BP).

Often IPA of USP, EP, or BP purity grade is sold as pharmaceutical grade. However, it is also common to see such IPA sold as medical grade or cosmetic grade or other names. Such names do not indicate official purity designations, and it is therefore important that the IPA, regardless of the label of the bottle, is of either USP, EP (or Ph. Eur.), or BP grade. Do not use IPA in the Merlin400 that are sold without one of these official grading designations.

There are IPAs of even higher purity grade than USP, EP, or BP. These purity grades are ACS (meeting or exceeding American Chemical Society standard) or reagent grade that corresponds to ACS grade. IPA of these purity grades are very expensive and almost always used for analytical, scientific purposes. Use of such IPA in the Merlin400 will be very expensive and will not improve the final product.

Different manufactures may use different labels, so always check the actual content and the official grading designations. The IPA sold by Drizzle is of EP (or Ph. Eur.) grade and sold as pharmaceutical grade IPA.

7.2 Herbs

All extractions begin with the herbs. They come in different types and qualities and provide extracts for different purposes.

7.2.1 Cannabis and hemp plants

You can make an extract of all parts of a dried cannabis or hemp plant, i.e. buds, leaves, trim, or AVB (already vaped buds) containing cannabinoids. The quality of the plant must be considered when choosing the desired application.

Application suitable for low (<10% cannabinoids) to high quality starting material:

- ✿ Decarbed drops
- ✿ Raw drops (non-decarbed)
- ✿ Edibles
- ✿ Enhanced herbs
- ✿ Lotions

Applications suitable for medium (>10% cannabinoids) to high quality starting material:

- * All the applications above
- * Oil cartridge vaporizers
- * E-cigarette
- * Dabbing

Read more about making extracts for the different applications in the section "Using the extract".

Merlin400 will create a full-spectrum extract, containing roughly the same ratio of cannabinoids (the active components) and terpenes (the fragrant components) as the original herbs. Because the ratios are kept intact, you can craft your favorite extract with the same properties as your favorite herbs.

You can expect a very consistent batch-to-batch quality, meaning that two extractions performed on the same starting material will be near identical.

Common types of cannabis

Cannabis is a plant and its flowers contain a number of compounds, some we want to avoid (mainly wax and chlorophylls), some compounds we want to obtain. When making extracts, we are interested in obtaining cannabinoids, terpenes, and flavonoids. Cannabinoids are a large group of compounds, with CBD and THC as the most prominent and well-known. The contents of cannabinoids differ greatly between the different types of cannabis. Terpenes are the main part of the essential oils in the herbs, while flavonoids are vitamin-like substances providing anti-oxidant and anti-inflammatory effects.

Seeds are heavy compared to buds, but since hemp seeds do not react to alcohol extraction, they will not contribute to the extraction in any way (hemp seed oil is made by pressure extraction).

Merlin400 makes a full spectrum extraction, meaning that cannabinoids, terpenes, etc. are extracted with the same footprint, as in the plant. Because of the carefully controlled extraction parameters, the extracts from Merlin400 are of a higher purity than not automated extractions like RSO (Rick Simpson Oil) and FECO (full extract cannabis oil).

Industrial hemp

The name hemp is often used for cannabis grown for seeds and fibers, not for cannabinoids. Hemp is grown outdoors and is the most abundant and cheapest cannabis type. Traditionally hemp has only been available for industrial use, but it is increasingly becoming available for private users via webshops etc.

Extracts from hemp are the typical source for industrially produced CBD oils. Merlin400 is designed to extract hemp's cannabinoid content, which is otherwise too low for home extraction. Hemp typically contains 0,2-15% CBD, and 0-1% THC.

Cannabis

Cannabis, also known as pot, weed, marijuana, is the Latin name for all the strains and types mentioned here but is often associated with the typical, outdoor-grown 'pot', which is grown for its content of both CBD and THC.

Because of the natural growing conditions, outdoor-grown cannabis has the widest range of different cannabinoids, terpenes, and lipids (called the entourage), giving the most complex range of tastes and effects. The cannabinoid content can vary a lot, from approximately 2-30% of both CBD and THC.

Skunk

Skunk is indoor-grown cannabis. Growing conditions (light source, fertilizer, temperature, ph-value, etc.) make a big difference in quality, smell (as the name skunk indicates), and content of the herbs.

Also, skunk represents the widest variety in strains, including auto-flowering, feminized, and crossbred strains. Many of these strains can also be grown outdoors, but the different types have mainly been bred by and for indoor growers. Techniques like growing from cuttings, feminizing seeds, etc. has mainly been developed by and for indoor growers. Traditionally skunk is grown for the THC content, which can reach up to 30% of the flower weight.

CBD skunk

CBD-skunk is like 'normal' skunk, but the strains have been bred to produce CBD rather than THC. By using CBD-skunk rather than hemp, you can produce CBD extracts with surprisingly high quality and yield.

7.2.2 Other plants

The extraction of oils from plants, fruits, and herbs is growing in popularity and there is almost unlimited room for experimentation of extraction. Merlin400 can make extracts from all parts of plants, e.g., roots, leaves, flowers, bark, berries, and nuts.



IMPORTANT! Not all plants are suitable for extraction and some may damage your Merlin400.

There may be toxic components (or allergens) in plants, and it is strongly recommended to use common sense and consult relevant literature before conducting extractions with new plants.

The guarantee on the Merlin400 only cover extracting of plants that has been mentioned explicitly on our website. We will continuously update our website with plants that are safe to extract using the Merlin400. Please contact us at support@drizzle.life if you are in doubt.

General information and guidelines

Generally we have found the following guidelines useful, if you want to experiment with the extraction of plant oils:

- * All plant parts must be completely dry without any water before extraction is commenced.
- * Some plant extract has such a strong smell or taste that it may be challenging to clean your Merlin400 after use.

Essential oils are fragrant oils most often extracted from plants with a strong, pleasant aroma. Oil extracts from plants with putative therapeutic properties are often called botanical extracts and are e.g. used in various skin and hair products. Often botanical extracts are added to skincare products for their antioxidant, anti-inflammatory, and antimicrobial effects.

There are many ways to extract oil from plants, and the process must match the different types of plants and flowers used. Extraction with alcohol as IPA often gives good results. Merlin400 is well suited for gently preparing plant oils since the evaporation of the IPA is performed at a low temperature (45 C) during most of the distillation process.

The extraction process depends on the localization of the wanted plant oils.

Some plant oils (often essential oils) are produced by specialized plant cells, which secrete them into very tiny sacs or glands.

- * This process is very similar to how the cannabis plant secretes cannabis oil, and such oils may be extracted using the techniques described in this manual for extracting cannabis oil.

Other plant oils are located inside the plant tissue. Such oils can best be extracted in a closed-lid jar containing plant parts and IPA. The extraction may take weeks or even months to obtain the highest plant oil concentration. At the end of the extraction, the mixture of IPA and plant parts must be filtered, e.g. by using a coffee filter. For a finer filtration, you can use the herb tube and filter.

- * After the filtration, the enriched IPA can be poured into the distillation chamber of Merlin400, and distilled using Program 4 "Distillation Only".

Below you will find examples of the extraction of plant oils, that we have tested.

Extraction of paprika

The herb tube was filled with paprika (35 g), and extraction was done similarly to cannabis extractions. The resulting extract (3.26 g) was of thick, oily consistency, and the intense taste of paprika was at first mild but with a strong aftertaste. Cleaning the Merlin400 after the paprika was time-consuming.

Extraction of hazelnuts

Crushed and dried hazelnuts (130 g) were soaked in IPA for four days. After filtration of the slurry, the opaque IPA was distilled in the Merlin400. The yield was 23,3 grams of oily extract that spontaneously separated in two layers (an upper transparent layer and a lower milky layer). Both layers had an exquisite, mild hazelnut taste with a long-lasting pleasant aftertaste.

Extraction of walnuts

Crushed and dried walnuts (60 g) were soaked in IPA for 140 minutes, drained, and washed with an additional 95 ml IPA. The yield was 12 grams of oily extract that spontaneously separated into two layers. Both layers had a beautiful, rich walnut taste.

8. HOW MERLIN400 WORKS

So, what happens inside Merlin400 during an extraction?

An extraction separates the valuable parts of your herbs from the unwanted parts. Merlin400 performs an alcohol extraction by washing the cannabinoids and terpenes out of the plant material with IPA and then removing the IPA by distillation. The ingredients and chambers each fulfill a function as described in the following:

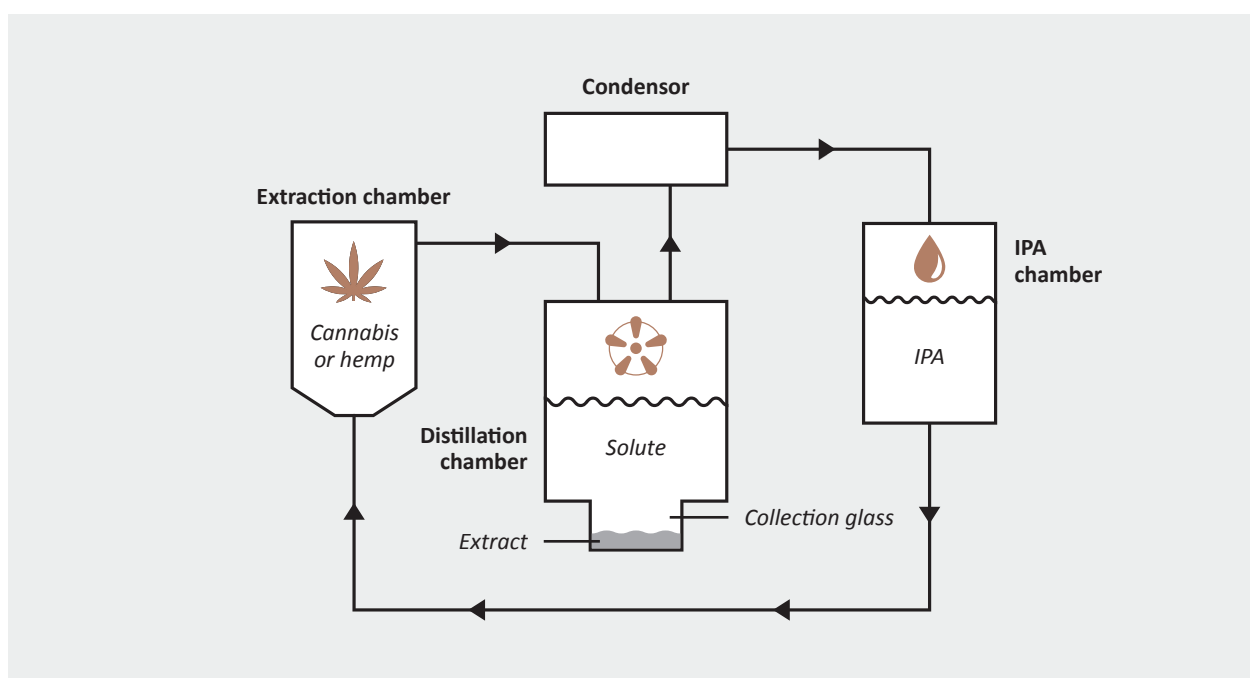

Merlin400 draws the IPA through the herb tube during the extraction, creating a solute (mixture of IPA, cannabinoids, and terpenes). The solute is transferred to the distillation chamber where the IPA is distilled from the solute and recycled as pure IPA back to the IPA chamber.

The raw extract is the product you want, and it remains in the collection glass, after you have run Program 1: “Make Extract”. The next section guides you to different ways you can use the raw extract.

9. USING THE EXTRACT

There are many ways to use the raw extract. Depending on the type of application you are interested in, you can make different post-extraction treatments. These are described in this section. Normally the raw extract from a medium strength herbs is ~60% cannabinoids. It is less for lower qualities and higher for high quality herbs.

9.1 Decarboxylation

The natural 'raw' form of the cannabinoids, as they form in the herb, are carboxylic acids. This means a specific group of carbon, oxygen, and hydrogen atoms are attached, affecting their chemical properties. These groups can be removed in a process called decarboxylation. To get the decarboxylated form is frequently referred to as 'activating' the cannabinoids.

For some uses, the raw form (often written as CBD-a, THC-a, etc.) of the cannabinoids is best. For others, the activated, or decarboxylated, state (CBD, THC, etc) is best. For instance, the 'high' from cannabis primarily comes from decarboxylated THC.

The medical properties of both CBD, THC, and the other cannabinoids seem to some extent to depend on whether the cannabinoids are in raw or activated form. You can find more information on the internet, however, be aware to find reliable sources.

The extraction process in Merlin400 happens at low temperatures, producing extracts in the raw, carboxylic form, just like the compounds that appear in the herbs.

Decarboxylation is obtained by heating the cannabinoids. It is a delicate process because when heating the extract, you also degrade and evaporate a number of other compounds, mainly terpenes. We have measured and defined the narrow time/temperature 'window' where decarboxylation happens effectively, with minimal degrading effects.

Program 2: "Decarboxylate" is for activating your extract. See section "11.2 Program 2: Decarboxylate" for instruction on how to use the program.

9.2 Why mix with a carrier?

Some applications of extracts require them to be diluted since the extract itself is very concentrated. If the extract is intended for either oral use, or in an e-cigarette, the extract needs to be mixed with either a suitable edible oil or a liquid suitable for an e-cigarette.

Merlin400 can help you mix extracts with a carrier oil or liquid by gently heating the extract to make it fluid. At room temperature, the extracts are almost solid, but they will soften and melt as the temperature rises.

Program 3: "Heat, melt and mixing" heats your extract in the collection glass to a temperature where it becomes soft and fluid, without degrading or decarboxylating the extract. See section "11.3 Program 3: Heat, melt and mixing" for instruction on how to use the program.

9.3 How to weigh your extract

No matter how you plan to use your raw extract, the dosage is important. And since extracted cannabis is very potent, you need to know the weight in grams, preferably with 3 decimal places (e.g., 1,234 grams). A suitable scale can be purchased in the Drizzle webshop.

Here is how you get a precise measurement of the weight of your raw extract:

Measure the tare weight (the collection glass and glass beads) before inserting the collection glass in Merlin400.

When the extraction is done, measure the gross weight (the collection glass, glass beads, and the raw extract)

Subtract the tare weight from the gross weight, and you have the weight of your extract.

Weigh of extract = Gross weight - Tare weight

9.4 How to calculate the amount of carrier oil

Since the extract is quite potent you can dilute the raw extract.

First, decide upon the dilution you want of your oral drops. This could be anything from roughly 3-50%, depending on the strength you want. We recommend to start with 10% and then find the level suitable for you.

**Then you use the formula: $x = (100-p) / p$,
where x is “part carrier oil/liquid per part extract”, and p is the “dilution percentage” you want.**

Don't panic. Here are a few examples:

- * If you want a 20% dilution, the calculation is $(100-20)/20 = 80/20 = 4$. Meaning that your mix should be 1 part extract and 4 parts carrier oil.
- * If you want a 12% dilution, the calculation is $(100-12)/12 = 88/12 = 7,33$. Meaning that your mix should be 1 part extract and 7,33 parts carrier oil.

Let us say, your extraction gave 1,23-gram yield:

- * For a 20% dilution you must add 4,92 g carrier oil ($4 \times 1,23 \text{ g} = 4,92 \text{ g}$).
- * For a 12% dilution you must add 9 g carrier oil ($7,33 \times 1,23 \text{ g} = 9 \text{ g}$).

9.5 List of Applications

The following list provides the basic characteristics of a number of typical cannabis applications, you can find much more information on the internet.

Raw oral drops (not decarbed)

Raw drops are for oral consumption. The terminology “drops” is used when the raw extract is mixed with a carrier oil. Raw drops are without decarboxylation.

Decarbed oral drops

Decarbed drops are for oral consumption. The terminology “drops” is used when the raw extract is mixed with a carrier oil. Decarbed drops have been decarboxylated before being diluted with carrier oil.

Raw extract for edibles

For cold edibles (smoothies etc.), you will typically use decarbed oils. For edibles that get heated (cookies baked in an oven etc.) the heat from baking will perform the decarboxylation. In this case, use the raw extract as starting material.

Extracts in oil vape pens

Many people prefer to use raw extracts in mixes for vaporizers and vape pens. You can use decarbed extracts, but this will be less fragrant, and the cannabinoids will be degraded from being heated two times, first in the decarboxylation, then again in the vape. One of the big advantages of Merlin400's extraction method is that the final product will have a very low content of fat / wax (compared to uncured rosin for example). This means that you can use it directly in a vape cartridge without any further processing. When using the extract, you can fill the undiluted extract in a cartridge and vape it using an oil vape pen. Alternatively, you can dilute it with terpenes first to add taste and make the mix more fluid. To mix, and/or to handle the extract easier, preheat on Merlin400 using “Program 3: Heat and melt for mixing”.

E-cigarettes

Like with oil vape pens, most people prefer to use the raw extract when mixing e-liquid for e-cigarettes. Mix your extract with an e-cigarette carrier and (optionally) terpenes in the collection glass. Find the correct ratio in e-cigarette guides. To easily make a homogenous mix, use Program 3: Heat and melt for mixing. Fill the mixture into the cartridge or tank on your e-cigarette, and puff away!

Dab

Dabbing is much like oil vape pens but a whole topic in itself. Like with oil vape pens, most people prefer to use the raw extract for dabbing. Place the raw extract directly in the dab pen or the dab rig. Heat and enjoy!

Enhanced herbs

Enhanced herbs are used in a dry herb vaporizer or for smoking. The herbs can be cannabis of both high and low qualities, and other herbs suitable for inhaling e.g. sage, mullein, rosemary, strawberry leaves, etc. Melt the raw extract using Program 3: Heat and melt for mixing. Add dry, grounded herbs in a ratio from 1:3 up to 1:20 (extract:-herb). Mix the raw extract with the dry herbs and massage the mixture into an even blend.

Lotions

Cannabis lotion is a relatively new way of using extracts. The extract is mixed with a lotion directly on the skin for external use. People use lotions to remedy arthritis, as anti-aging agents, etc. To make a lotion, mix raw or decarbed extract with a neutral lotion in a ratio from 1:200 to 1:10 (extract:lotion).

10. STARTUP: GETTING YOUR MERLIN400 READY

1. Place your Merlin400 on a plane, clean surface. Keep Merlin400 away from ignition sources.
2. Plug the power cord into the machine and wall outlet (110 to 230V). The start button will blink green indicating the initialization process.
3. After a few minutes, start will show a constant green light indicating Merlin400 is now ready to begin extraction.

11. PROGRAMS

Merlin400 has four programs, as explained on the following pages:

1. Make extract (~ 150 min).
2. Decarboxylate (~ 30 min).
3. Heat and melt for mixing (~ 10 min).
4. Distillation only (time depends on the amount of IPA present).

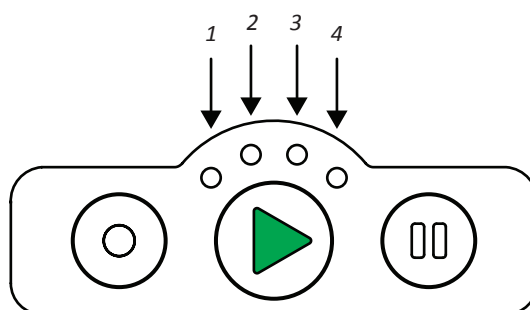

The programs are selected via the select and start button on the user panel or via the Merlin400 app.

The app also has extra maintenance and software updates functions, including the programs “Extraction only”, “Vent Valves”, “Maintenance”, and other functions. Read more in the Merlin400 app section or online.

11.1 Program 1: Make extract

This is the main program of Merlin400, which produces the non-decarboxylated raw extract.

The “Make extract” program performs a fully automated extraction of the herbs of your choice, including a distillation to remove and recover IPA. When the program is finished, the raw extract is found in the collection glass, ready to use as is or for processing according to the desired application.

11.1.1 Preparations

Prepare the herbs

The herb tube holds ~25-40 g of herbs, depending on the herbs’ granulation size and oil content. Finely grinded herbs (1-5 mm grain size) will give a higher yield of a darker color. Coarsly grinded herbs will give a lighter oil but a lower yield. Oil-rich cannabis will pack more ‘fluffy’ than oil-scarce industrial hemp and lower quality cannabis (trim etc.). See section “7.1 Herbs: Common types of cannabis”. The small herb tube (~12-20 g) can be purchased from the Drizzle webshop.

1. Make sure your herbs are completely dry.
2. Select the proper amount for your extraction: This is typically 25-35 g for high-quality cannabis without seeds and 30-40 g for low-quality hemp. The amount has to be enough to fill the herb tube.
3. Bigger stalks (over 1-2 cm) should be removed.
4. Blend or grind the herbs according to your preferences.

Pack the herb tube

For proper function and maintenance, the herb tube needs to be carefully packed and filled to the top. The herbs in the tube should be packed tightly, without air pockets reducing the extraction efficiency. If you only pack the herb tube partially, herbs will be flushed into the machine and clog the inner channels.

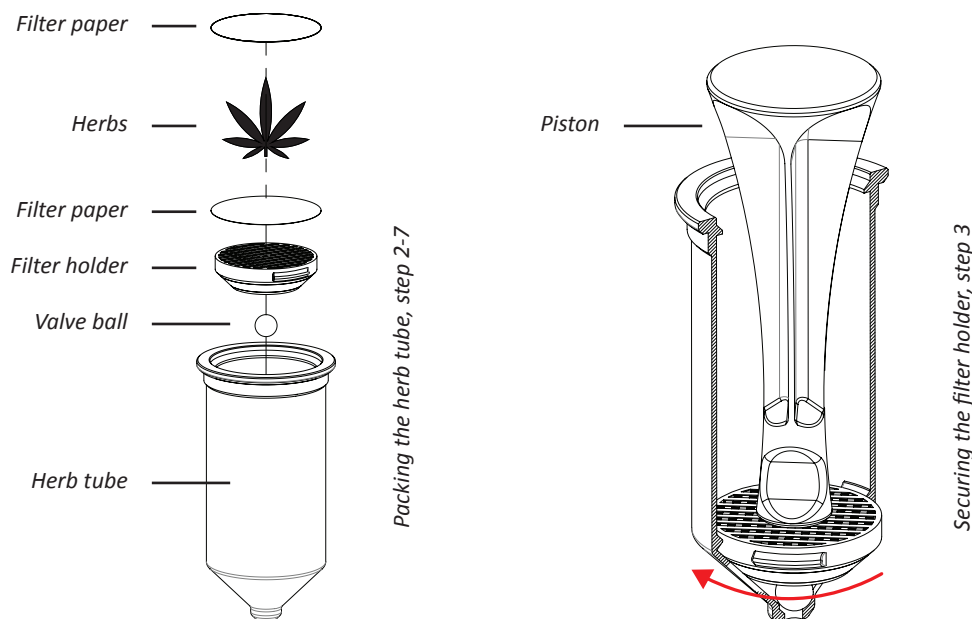

1. Place the herb tube in the tube holder.
2. Place the valve ball and the filter holder in the herb tube.
3. Secure the filter holder by rotating it, using the back end of the piston.
4. Place a filter paper on top of the filter holder.
5. Place the funnel on top of the tube and fill the tube about ½ with herbs.
6. Use the piston to firmly pack the herbs into the tube, using moderate force (2-5 kg).
7. Repeat the filling and compressing until the herbs reach the top of the tube.
ATTENTION! The tube is packed correctly when you can compress the herbs a bit when you push with a finger, but the herbs should bounce back up when you release the pressure.
8. Remove the funnel and place a filter paper on top of the starting material. Use the piston to press slightly down on the filter, so that it attaches under the inner rim at the top of the tube. The paper must have a tight fit under the edge so that plant material does not get flushed into the internal channels of Merlin400, causing them to be clogged.
9. Wipe or blow the surface clean, and the herb tube is ready for use.

Prepare the 3 chambers



Prepare the IPA chamber

1. Open the lid and place the funnel on top of the IPA chamber.
2. For an empty chamber, pour 0,35 - 0,6 L IPA into the chamber. If there is already IPA in the chamber, then refill until the IPA reaches the line on the inner side of the chamber, indicating the maximum filling level (3-5 cm from the upper edge).
3. Close the lid.



Prepare the extraction chamber

1. Open the lid.
2. Check that the two gaskets (one in the lid and one at the bottom) are clean and in place.
3. Place the packed herb tube in the extraction chamber.
4. Close the lid.



Prepare the distillation chamber

1. Put 2-3 glass beads inside the collection glass to prevent bumping during boiling.
2. Place the collection glass on the heat bed.
3. Turn the elevator ring to the left (clockwise) to lift the elevator until there is an airtight seal between the collection glass and the gasket at the bottom of the distillation chamber. If the glass can be turned around, then tighten the ring a little more.



ATTENTION! For many of the applications, you need to know the product's weight (raw extract). See how to do this in the "How to weigh your extract" section.

11.1.2 Checklist before extraction

Before starting an extraction, go through the following checklist:

- * Is the IPA chamber filled with min. 350 ml IPA or up to the max marking on the inside?
- * Is the herb tube packed correctly and placed in the extraction chamber?
- * Are there 2-3 glass beads in the collection glass ?
- * Have you (optionally) measured the tare weight of the collection glass and glass beads for later?
- * Is the collection glass placed correctly on the heat bed, making an airtight closure to the distillation chamber?
- * Are all lids closed tightly?
- * Is the light on the start button a constant green one?

When the preparations above are done, you are ready to start the extraction.

11.1.3 Start the extraction

1. Press the select button to toggle to "Program 1: Make extract" (~150 min.). You have selected the right program when the start button is green and the 1st indicator light is lit.
2. Press start.
3. After a few minutes, the elevator light will turn on.
4. Check that the elevator ring is still tight.

11.1.4 During the program

During the extraction, Merlin400 will draw IPA through the herbs in the extraction chamber and into the distillation chamber, where you can see the solute in the collection glass. During the distillation, you can see bubbles in the glass.

11.1.5 Finish the program

1. The extraction program has finished when the light in the collection glass turns off and the light on the start button is a constant green one.
2. Clean all internal and external parts. See section "12.1 Basic cleaning: After each run" for instructions on cleaning and maintenance.



Collection glass with 1,4 grams extract.



Collection glass with 3,6 grams extract.

11.2 Program 2: Decarboxylate

This program decarboxylates the raw extract, see section “9.1 Decarboxylation” for more information about this process and when it is used.

11.2.1 Preparations

1. Take a collection glass containing raw extract. It is fine to leave the glass beads in the collection glass.
2. Place the collection glass on the heat bed.
3. Open the elevator so there is a min. 1 cm gap to avoid excess heating of the distillation chamber.

11.2.2 Checklist before start

Before starting a decarboxylation, go through the following checklist:

- * Is there raw extract in the collection glass?
- * Is the collection glass mounted correctly on the heat bed in the elevator?
- * Is the elevator closed? For decarboxylation, the elevator should be closed to avoid the loss of terpenes.
- * Is the start button lit with a constant green light?

When the preparations above are done, you are ready to start the decarboxylation.

11.2.3 Start the decarboxylation

1. Press the select button to toggle to “Program 2: Decarboxylate” (~30 min.). You have selected the right program when the start button is green and the 2nd indicator light is lit.
2. Press start.

11.2.4 During the program

The raw extract will be heated to the decarboxylation temperature and kept there until the process is finished. The extract will start to form small bubbles when heated, indicating the decarboxylation process. If you are using high-quality material, you may also note a cannabis smell from the machine, which is entirely normal. During the program, the elevator light will illuminate the glass so you can follow the process.

11.2.5 Finishing the program

The decarboxylation program takes about 30 minutes to complete. Let the program run until the light in the collection glass turns off, and the start button stops blinking and is constant green.

1. When the glass is cool enough to touch, you can remove the collection glass with the decarbed extract. The decarbed extract can be used for the same applications as the non-decarbed raw extract but is different in taste and effects, see section “9.1 Decarboxylation”.

11.3 Program 3: Heat and melt for mixing

This program heats your extract in the collection glass to a temperature making it soft and fluid, without degrading or decarboxylating the extract. It can be used with either a raw extract or a decarbed extract. For oral drops, mix with an edible oil. For e-cigarettes, mix with an e-liquid.

11.3.1 Preparations

To melt and mix your extract, follow these steps:

1. Take a collection glass containing extract. It is fine to leave the glass beads in the collection glass.
2. Choose an edible oil of your liking or an e-liquid.
3. Calculate the amount of edible oil or e-liquid needed (see section 9.4).
4. Use a pipette to add the calculated amount of edible oil or e-liquid to the collection glass with raw extract.
5. Place the collection glass on the heat bed.

11.3.2 Checklist before start

Before starting the heat, melt and mix program, go through the following checklist:

- * Is there extract and edible oil or e-liquid in the collection glass?
- * Is the collection glass placed correctly on the heat bed? For heating, it is not necessary to close the elevator.
- * Is the light on the start button a constant green one?

When the preparations above are done, you are ready to heat.

11.3.3 Start the heating

1. Press the select button to toggle to Program 3 - Heat and melt for mixing (~10 min). You have selected the right program when the start button is green and the 3rd indicator light is lit.
2. Press start.

11.3.4 Finishing the program

When the program finishes after ~10 min, the extract has been melted and is easy to mix with the carrier.

1. Take the collection glass out and stir the content, e.g., using the pipette tip.
2. Use the pipette to transfer the finished product into a suitable container: pipette bottle or e-cigarette cartridge.

11.4 Program 4: Distillation only

Program 4 is mainly used to recover IPA from different fractions of IPA that may have been removed from Merlin400. This can be solute (the combination of IPA and the extract from the herbs) or used IPA that you want to clean and recycle. See section 15.1 “Clean used IPA” for more information. As the name indicates, the program will perform a distillation of whatever is in the distillation chamber.

11.4.1 Preparations



Prepare the IPA chamber

Empty the IPA chamber for IPA using the syringe. Alternatively, make sure there is plenty of room for the recycled IPA (at least 210 ml).



WARNING: Check that the IPA chamber has room for the recycled IPA before starting a distillation. If not, you risk flooding the IPA chamber when the recovered IPA is returned to the chamber. This can damage the electronic components of Merlin400 and risk ignition. IN CASE THE CHAMBER IS FLOODED, AND IPA IS LEAKING, UNPLUG THE POWER CORD AT ONCE AND CLEAN UP ALL IPA BEFORE RECONNECTING POWER.



Prepare the distillation chamber

1. Place the collection glass with glass beads on the heat bed.
2. Turn the elevator ring left (clockwise) to lift the elevator until there is an airtight seal between the collection glass and the gasket at the bottom of the distillation chamber. If the glass can be turned around, then tighten the ring a little more.
3. Open the distillation chamber lid.
4. Add max. 210 ml used IPA to the distillation chamber. If you add more than 210 ml, you will flood the internal channels in your Merlin400.
5. Check that the gasket is in place and close the lid to the distillation chamber.

11.4.3 Checklist before start

Before starting distillation, go through the following checklist:

- * Are distillation chamber and gaskets clean and in place?
- * Is the collection glass and glass beads mounted on the heat bed?
- * Is the collection glass tightly sealed to the gasket at the bottom of the distillation chamber?
- * Is the used IPA you want to distill in the distillation chamber, without exceeding the MAX marking inside the distillation chamber to avoid flooding the holes on the inside wall of the chamber?
- * Is there enough room in the IPA chamber for the amount of IPA you want to distill?

When the preparations above are done, you are ready to distill.

11.4.4 Start the distillation

1. Press the select button to toggle to Program 4: Distillation only. You have selected the right program when the start button is green and the 4th indicator light is lit.
2. Press start.

During the distillation, the recovered IPA is returned to the IPA chamber. The remaining non-IPA content of the solute is left in the collection glass.

11.4.5 Finishing the program

When done, the recycled IPA will be in the IPA chamber, and the unusable residue will be in the collection glass.

1. Check the IPA has been distilled from the collection glass.
2. Discard the unusable residue in the collections glass.

12. MAINTENANCE

Take good care of your Merlin400! This will help avoid malfunctions like air leaks, clogged tubes, or residues from one extraction making their way into the next. Failure to follow the maintenance guide may void the warranty.

Basic cleaning of Merlin400 should be conducted after each extraction and a more thorough cleaning should be conducted after 10 extractions or when needed.

12.1 Basic cleaning: After each run

After each run of Merlin400, you have to clean the herb tube, the collection glass, the extraction chamber and the distillation chamber, which are in direct contact with the herbs or extract.

12.1.1 Clean the herb tube and collection glass

To clean the removable parts of Merlin400:

1. Remove the herb tube from the extraction chamber.
2. Remove the used herbs from the herb tube using the back end of the piston.
3. Discard the used herbs and the two filter papers. See section 12.1.2.
4. Remove the filter holder and the valve ball from the herb tube by using the back end of the piston to turn and unlock the filter holder.
5. Wash the plastic parts (herb tube, filter holder, and piston) with water: Do not use a dishwasher or soap on the plastic parts. If needed, you can also wipe using small amounts of IPA on a paper towel.
6. Clean the valve ball, collection glass, and the glass beads using water and soap. You can also wipe using small amounts of IPA on a paper towel.
7. Dry everything carefully.

12.1.2 Disposal of the used herbs

Be aware that the used herbs are soaked with IPA and are highly flammable! Keep away from ignition sources. To avoid placing flammable content directly in your bin you can dilute the soaked herbs with water. Like ethanol, IPA can be flushed in the drain.

1. Empty the contents of the herb tube into a bowl and soak with water to dilute the IPA.
2. Strain or pour the water from the herbs.
3. Dispose of the herbs in your trash bin or compost.



12.1.3 Clean the extraction chamber

To clean the extraction chamber:

1. Open the top lid.
2. Remove any remaining solute (IPA with herb extract) from the bottom of the extraction chamber using the syringe. Optionally, you can distill and recycle the IPA from the solute using the “Recover used IPA” procedure.
3. Clean the gasket in the lid using a small amount of IPA on a paper towel.
4. If necessary, wipe the extraction chamber clean with the paper towel.



12.1.4 Clean the distillation chamber and the elevator

To clean the distillation chamber and the elevator:

1. Open the top lid.
2. Remove the gasket from the groove at the top of the distillation chamber and wipe it clean using small amounts of IPA on a paper towel.
3. Wipe the distillation chamber clean with a paper towel.
4. Replace the gasket in the groove and make sure it is fitted correctly.
5. Replace the top lid. Do not over tighten the lid.
6. Clean the gasket connecting the distillation chamber and the rim of the collection glass with the paper towel using IPA on a paper towel.
7. Clean the heat bed. Even small amounts of residue will reduce heat transfer and cause a longer distilling time.

12.2 Extended cleaning: After every 10th run

The internal tubes and channels in the Merlin400 should be cleaned regularly, and we recommend doing an internal wash after every 10th run or as needed. The internal wash is done by running an extraction cycle without any herbs.

To make an extended cleaning of Merlin400:

1. Open the lid to the IPA chamber (drop imprint).
2. Remove all IPA from the IPA chamber using the syringe.
3. Add 400-500 ml new IPA to the IPA chamber.
4. Close the lid.
5. Insert the clean, empty herb tube in the extraction chamber (hemp leaf imprint).
6. Run Program 1: “Make extract”.
7. Wait for the program to finish
8. Remove and clean the collection glass.

If collection glass contains colored parts or old plant material, you can repeat the washing cycles until it is clean.

12.3 When to change IPA

Merlin400 is designed to collect the distilled IPA to be reused in several extractions. During use, small residues of leftover chlorophyll will give the IPA a green tint, and once in a while, the IPA should be changed.

Light green IPA can be used for extraction without any disadvantages. Medium green IPA can give a harsh taste to the extract made with it, but will not otherwise harm the extract. Dark green IPA should be changed.

To change the IPA in the IPA chamber:

1. Open the lid with the drop imprint.
2. Remove all IPA from the IPA chamber using the syringe.
3. Add new IPA (~ min.350, max 570 ml) to the IPA chamber.
4. Close the lid.

You can recycle the green IPA. See the instructions in section 15.1 “Clean used IPA”.

13. ERRORS AND ERROR CODES

This section will guide you through the errors that can occur when using the Merlin400 and how to handle them.

13.1 How to deal with an error

If an error occurs, the start button on the user panel will turn red, and a combination of indicator lights will show the nature of the error. See the list of error codes in section 13.3.

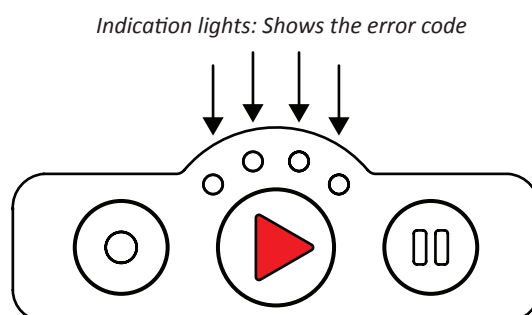

In the app, errors will also show up as a notification, along with a short description to guide you. When an error occurs, Merlin400 will stop any running program. You then need to:

1. Find out what the error is, using the error overview below.
2. Go to the instructions for the given error.
3. Solve the error by following the instructions.
4. When the error has been solved, reset Merlin400. See section 13.2.
5. Determine if there is solute in the distillation chamber (Drizzle logo imprint).
6. If yes, run Program 4; “Distillation only” to finish the distillation.

If you cannot solve the error, please contact us at support@drizzle.life

13.2 Reset Merlin400

After resolving the error, reset your Merlin400:

1. Press and hold the select and the pause buttons on the user panel simultaneously for 5 seconds (select+pause).
2. The indicator lights will flash slowly at first, then more quickly. Merlin400 will reboot and enter ready state if the error is solved. The light on the start button will again be a constant green one.

Should Merlin400 not respond to any input, you can perform a hard reset:











1. Disconnect the power cord from Merlin400.
2. Wait 5 seconds.
3. Reconnect the power cord.

Merlin400 will then perform the initialization procedure and enter the ready state.

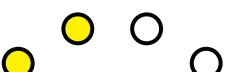
13.3 Error overview

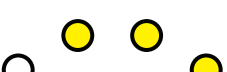
If the start button is red, the four indicator lights will display an error code. For example, light no. 1 and 2 will be lit to indicate error code 5: Heater error.

This table provides an overview of the errors, you may encounter:

ERROR CODE	ERROR NUMBER	ERROR DESCRIPTION
	1	Leak in distillation chamber
	2	Leak in extraction chamber
	3	IPA gas level too high
	4	A tube or valve is blocked
	5	Heater error
	6	Pump needs cleaning
	7	Electrical error
	8	Insufficient vacuum for distillation
	9	Temperature of heat plate too high
	64	Unknown error



Error 1 - Leak in distillation chamber

Problem: The distillation chamber is not airtight. Merlin400 needs to create a vacuum in the distillation chamber several times during the extraction process. If it leaks, it will return an error. The leak is most often caused by a misplaced or dirty gasket, either the top gasket in the groove under the lid, or the bottom gasket between the distillation chamber and the collection glass.

Solution:

1. Check that the collection glass is properly in place, and that both the lid and the elevator ring are tightened.
2. Check that the top gasket (in the groove under the lid) and the bottom gasket (meeting the collection glass) are clean and in place.



If the gaskets are dirty or greasy from earlier extractions, they need to be cleaned to make an air-tight seal:

- * The top gasket can be removed and cleaned with cloth or paper soaked in IPA. Make sure the gasket fits tight when you replace it.
- * To clean the bottom gasket, use a piece of cloth or toilet paper soaked in IPA to dry off any residue. Be careful not to damage the fragile parts of the heater and elevator when you clean the backside of the bottom gasket.

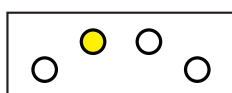

Error 2 - Leak in extraction chamber

Problem: The extraction chamber and the herb tube inside are not airtight. The leak is most often caused by a misplaced or dirty gasket, either the top gasket in the lid, or the small gasket at the bottom of the extraction chamber.

Solution:

1. Remove the herb tube. If needed, use the syringe to remove left-over IPA from the extraction chamber.
2. Check that both the top and bottom gaskets are clean, free from residual herbs and in place.
3. If needed, use the piston to push the small bottom gasket in place. Do not use any sharp objects for this.
4. Check for residual herbs in the lid, the upper edge of the extraction chamber and both ends of the herb tube.

If the above steps do not work, check that the lid of the extraction chamber is not broken. Check for small cracks. If you find cracks, don't hesitate to contact support@drizzle.life for a replacement lid.



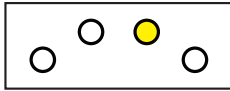

Error 3 - IPA gas level too high

Problem: Fumes of IPA can build up inside the Merlin400. The fumes are highly flammable, so the built-in alcohol sensor will shut the machine down before the fumes reach a critical level.

Solution:

1. Check for leaks and spills on the machine and the table it is standing on.
2. Wipe away any IPA spills, especially around the extraction chamber lid.
3. Vent the inside of the machine by blowing air into it. You can do this two ways:
 - Along the silicon tube on the left side of the lid, that goes into the machine (see picture for error 2).
 - On the back of the machine, through the lower part of the cooling fins (see picture below).



4. Reset the machine after venting. If the error persists, repeat this procedure. If the error still persists, wait 20 minutes, and try again.

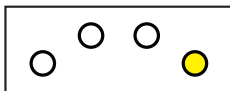

Error 4 - A tube or valve is blocked

Problem: A tube for transporting solvent or air inside the machine is blocked or the valve is stuck.

Solution:

1. Use the app to get the precise error description. The app will tell you exactly which tube is blocked.
2. Go to our website: drizzle.life Click the knowledge base. Under the Maintenance & Error Handling section, you will find the article: "Error 4 - Blocked tube". Follow the video guide to clean the tube.
3. If the cleaning fails, you may need to replace the tube. In that case, do not hesitate to contact support@drizzle.life for a replacement and assistance.

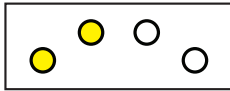

Error 5 - Heater error

Problem: The heating plate does not work correctly. This can happen if the heat fuse has melted, the internal cable is damaged, or the internal cable has been pulled out during maintenance.

Solution:

1. Make a hard reset of Merlin400 by unplugging the power cord and leaving it for 15 seconds.
2. Make sure the room temperature is above 15 degrees Celsius. Plug the machine in and let Merlin400 restart.
3. Run Program 3: Heat and melt for mixing.
 - If the light in the collection glass turns on and the heater gets warm, the restart has solved the problem. Reset and proceed with extraction as usual.
 - If the heater does not warm, and you have no light in the collection glass, the heater plug has probably been unplugged.
 - If the error persists and you have light in the collection glass, you probably have a melted thermal fuse.

If the error persists, please get in touch with support@drizzle.life and report your findings from step three so we can help you effectively.

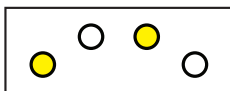

Error 6 - Pump needs cleaning

Problem: The pump has become clogged with residue from the extractions. This can lower the pump's efficiency to a point where it cannot produce the necessary vacuum in Merlin400.

Solution:

1. Reset the machine.
2. Use the app to run "Vent Valves". If this does not solve the problem, or if you do not have access to the app, then disconnect Merlin400 from power and leave it off for at least 15 seconds. Connect it again and perform an "Extended cleaning" as described in the maintenance section.

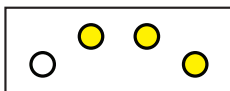

Error 7 - Electrical error

Problem: The Merlin cannot communicate with critical components on its main board.

Solution:

1. Switch off the machine, leave it off for 15 minutes and then try again.
2. If it does not work, please get in touch with support@drizzle.life and explain the problem.

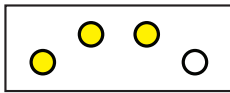

Error 8 - Insufficient vacuum for distillation

Problem: The distillation chamber cannot sustain a proper vacuum during the distillation process. A misplaced gasket most likely causes it.

Solution:

1. Check that the gasket under the distillation chamber lid is clean in place and that the lid is closed tightly.
2. If the error persists, perform the extended cleaning described in the maintenance section.
3. If the error still persists, the pump may be worn out. Contact support@drizzle.life

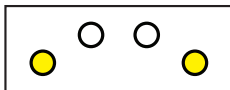

Error 9 - Temperature of heat plate too high

Problem: The temperature of the heater has exceeded its maximum level.

Solution:

1. Switch off the machine and leave it off for 15 seconds. Turn it back on and try again.
2. If the error persists, do not continue to operate the device and contact support@drizzle.life for assistance.

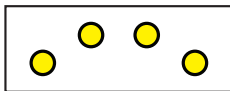

Error 64 - Unknown error

Problem: Unknown error

Solution: Congratulations, you have found a bug we did not know of, and we need your help to fix it. Please contact us at support@drizzle.life.

14. MERLIN400 APP

The Merlin400 app gives you two major advantages:

Software updates: We continuously improve the software and fix bugs. By using the app, you can install the updates for Merlin400 as they become available and get the best out of your Merlin400. We recommend you do this before using the machine for the first time.

Detailed insights into and control of Merlin400: Using the app you can dive into the details of what is happening in Merlin400 during runtime. You can monitor progress and key parameters, have full operational control of your Merlin400, and access additional programs. E.g., during the extraction process, you can see temperature, pressure, and estimated remaining time.

The Merlin400 app is an online app (PWA), which you access much like an ordinary webpage (connect.drizzle.life) using your phone, tablet, or pc.

This section is a step-by-step guide to the initial setup and use of the app.

14.1 Connect Merlin400 to internet and link with phone

Before you can use the app, you need to connect the online app and your Merlin400. This setup only has to be done once.

To set up Merlin400, you need WiFi with an active internet connection and a phone (or any similar device like a tablet or pc). The following guide has been written for a phone, but you can use a tablet or pc. Please be aware that if your phone or device has been linked to another Merlin400 device, you need to clear the phone browser cache first.

14.1.2 Connect to Merlin400s access point

Merlin400 has a built-in WiFi access point with a unique network name (SSID). While performing the setup, your phone must be connected to Merlin400 via this access point, not to your normal WiFi.

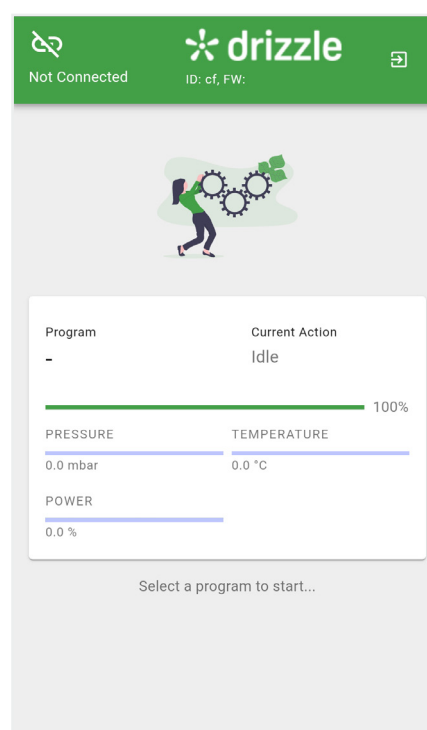
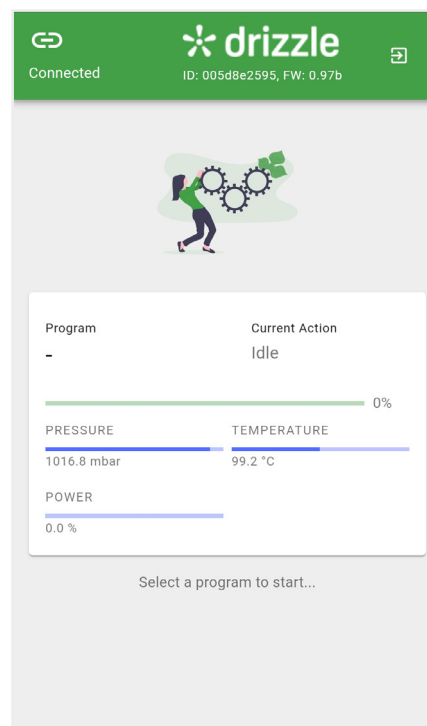

This is how you do the setup:

1. Find the network name (SSID) and password (PWD) for your Merlin400. These are located on the product label which you can find in two places: On the sticker on the back of this manual and on the back side of your Merlin400.
2. Get Merlin400 in ready-state. Turn on your Merlin400 and wait a few minutes until all initialization processes have finished and the start button has a constant green light.
3. Connect to Merlin400's access point. Go to your phone's WiFi connection settings and find your Merlin400's network name (SSID). Enter the password (PWD) and press "connect". Wait until the connection is established.
4. Your phone is now connected to your Merlin400.

Be aware that you might get a "limited connection" notification at this point. This is ok and occurs because your phone is linked to your Merlin400 and not your regular WiFi.

14.1.3 Configure Merlin400 to access the internet

1. Launch a browser on your phone, e.g. Safari, Chrome or Explorer.
2. Enter the address **setup.drizzle.life** in the address field of the browser. If you by mistake enter the address in a search field, instead of the address field, it will not work.

This address will take you to Merlin400's internal setup page, where you can give Merlin400 access to your normal WiFi connection.

1. Use the drop-down menu "Please select your WiFi connection..." to find and select the WiFi connection you want Merlin400 to use to access the internet. This will typically be your normal home WiFi, which you use for everyday internet access.
2. Press the "Connect Merlin's WiFi" button.
3. Enter the password for your WiFi access point.

Merlin400 will restart and your app will pause for approx. one min. while this is happening.

1. Press "OK" when the time has elapsed.
2. You can reconnect your phone to your regular WiFi connection at this point.

After Merlin400 has rebooted, you can check if it is properly connected to the internet.

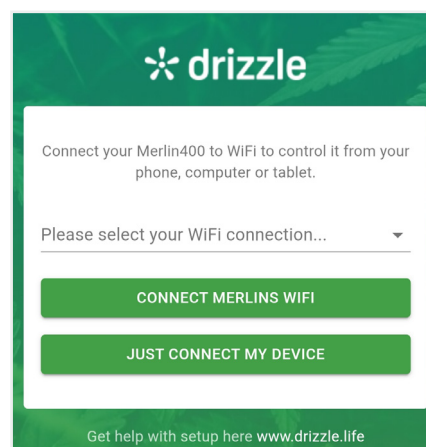
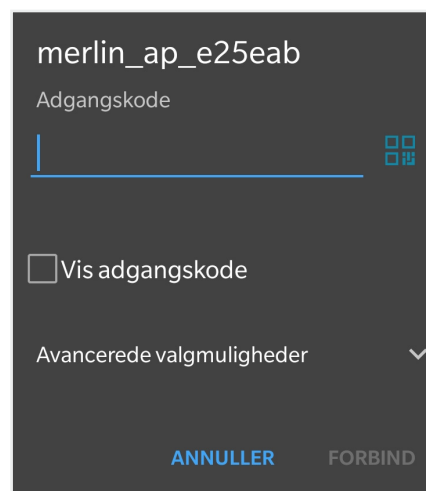

1. Press and hold the select button for a few seconds. If the start button blinks green, the internet connection is good. It might take up to one minute for Merlin400 to establish a connection, so give it a little time. If it still blinks red after a few minutes, go back and repeat this setup guide from step 1.

Your Merlin400 has now been set up, it is connected to the internet, and is ready to use via the app on the device you used for the process. Your browser should automatically go to <https://connect.drizzle.life> and look like the image on the right. From now on, you can use this link to access the app.

1. You can save the browser link to your phone for easy access. Press the three dots in the top right corner and select “Add to Home screen” or save the link as a bookmark in your browser.

14.2 Link another phone to Merlin400

You can have multiple devices connected to Merlin400 at the same time, or you can just switch to a new device. Merlin400 needs to be online before you can follow this section, so make sure to have completed the steps in section 14.1. Please be aware that if your phone or device has been linked to another Merlin400 device, you need to clear the phone browser cache first.

14.2.1 Connect new phone to Merlin400

Please follow the steps in section 14.1.2 and connect the new phone to Merlin400s access point.

14.2.2 Link phone

1. Launch a browser on your phone, e.g. Safari, Chrome or Explorer.
2. Enter the address setup.drizzle.life in the address field of the browser. If you by mistake enter the address in a search field, instead of the address field, it will not work.
3. Press the second button, “just connect my device”.
4. You can now switch your phone back to your own WiFi
5. The phone is now linked to the Merlin400

14.3 Update software

We continuously develop and improve the software to fix bugs and improve the programs. New updates are notified in the app, and we recommend that you always use the latest software version. If you choose not to update your Merlin400, it will still work, but only with the software and features installed at delivery. You can see your current software version in the top right corner of the app.

This is how you update your Merlin400 software:

1. Connect to the app at <https://connect.drizzle.life>.
2. Select “Settings” at the bottom right of the app.
3. Press “Upgrade Software”

The start button will show the progress of the update: While updating, it will blink red. After a few minutes, it will change to blink green while Merlin400 performs a restart. When the start button has a constant green light, it has finished, and your Merlin400 is updated with the latest software.

14.4 Use Merlin400 via app

When you use the app, more functions are available than via the user panel on the machine.

PROGRAM/FUNCTION	USER PANEL	MERLIN400 APP
Reset	X	X
Program 1: Make extract	X	X
Program 2: Decarboxylation	X	X
Program 3: Heat for mixing	X	X
Program 4: Distillation only	X	X
Extraction only		X
Vent valves		X
Clean pump		X
Manual valve control		X
Software upgrade		X
Send machine log		X

Program 1 to 4 are the same as those accessible via the user panel, the other programs and functions are explained in the text below.

To run the programs from the app, prepare your Merlin400 as normally - remember to review the pre-start checklists - and use the app to select and start the program you want:

- * Go through the pre-start checklist for the program you want to run.
- * When Merlin400 is ready, go to the program page in the app.
- * Select and start the program you want.

While the programs are running, you will be able to follow the progress, e.g. temperature and pressure.

14.4.1 Extraction only

This program is only available via the app. With the program, you can choose only to run the extraction, without the distillation. The program will result in the distillation chamber being filled with a cannabinoid-rich solute for further use. It will not be distilled automatically as with program 1.

14.4.2 Vent valves

This program is only available via the app. It is a cleaning program, useful if the pump and tubes have become dirty from oil and plant fat.

14.4.3 Clean pump

Only use this program if an extended cleaning procedure and the vent pump program fails to clean the pump. It will allow a higher temperature during the distillation process and causes more long-term wear to the machine.

To use the program:

1. Make sure there is a clean oil glass containing a few glass beads on the heatbed.
2. Ensure the elevator is closed and the glass is secure against the gasket.
3. Unscrew the lid to the distillation chamber, and pour in approximately 50-100 mL IPA.
4. Ensure the red o-ring is securely in place, and screw the lid back on the distillation chamber.

Use your app to start the “Clean pump” program. Merlin400 will automatically stop once everything is distilled away, but you can also stop it manually before time (press RESET).

14.4.4 Manual valve control

This program is helpful if you need to clean a clogged valve.

The buttons will allow you to open precisely one valve at a time and close the rest. Press the valve you want to open, and you will hear Merlin400 buzz faintly for a few seconds. Once it stops buzzing, the valve selected will be opened, and the rest closed.

Please refer to our website’s knowledgebase for guides on cleaning the valves.

14.5 Send machine log

With this function, you can compile a log from Merlin400 and send it to Drizzle. We can then help diagnose your Merlin400 and solve the issue you may have encountered.

15. TIPS & TRICKS

This section contains some useful methods to recover IPA and extend the yield.

15.1 Clean used IPA

Sometimes, the IPA in the IPA chamber turns green from use and sometimes you collect used IPA from low-quality herbs out of the herb tube. There are several Merlin400 processes where solute can be collected and later distilled to recover the IPA:

1. Basic cleaning. After each extraction remaining solute is removed from the bottom of the extraction chamber. See section 12.1.
2. Extended cleaning. After every 10th run, when Merlin400 is cleaned by running the extraction program with 180 ml clean IPA and without herbs. See section 12.2.
3. Changing IPA. If the IPA in the IPA chamber has taken color from the herbs and turned green. See section 12.3.
4. Recovering IPA from used herbs. If solute is drained and collected from the herb tube. See section 15.2.1.

You can clean and re-use the IPA by distilling it. Here is how:

1. Place an empty, clean herb tube in the extraction chamber, and close the lid.
2. Mount a collection glass with glass beads under the cleaned distillation chamber.
3. Open the top lid of the distillation chamber, and add min. 100ml, max 210 ml used IPA in the distillation chamber. You can use the syringe to measure the amount.
4. Make sure the gasket is in place and close the distiller lid.

ATTENTION! Make sure the IPA chamber has sufficient free space to receive the IPA during distillation.

5. Run Program 4: Distillation only.

After the distillation, the IPA will be in the IPA chamber ready for next use, and the leftovers will be in the collection glass. Clean the glass, and you are ready to re-use your IPA.

15.2 Advanced uses

There are some advanced uses that can be performed on the Merlin400:

- * Recover IPA from used herbs.
- * Using recovered IPA to increase the yield.
- * Multiple, cumulative extractions.



ATTENTION! These procedures require that you understand every step in the Merlin400 process since you will make manual adjustments to the automated process. We recommend getting familiar with the normal use before trying the advanced uses.

- * Advanced uses should be performed with care.
- * Be aware that these uses may void the guarantee if they are performed incorrectly.

15.2.1 Recover IPA from used herbs

When performing an extraction, some IPA will be left in the herb tube, along with the herbs. Some of this IPA can be collected and distilled for reuse. If you extract high-quality herbs, this process can also add to the yield of cannabinoids obtained from the extraction.

Here's how to recover IPA from used herbs:

1. When running Program 1, the light in the collection glass will turn on after a few minutes. This indicates that the extraction part has finished and the solute has been transferred to the distillation chamber. Check if the light behind the collection glass has turned on.
2. At this point, you can carefully open the lid to the extraction chamber (hemp leaf imprint). The extraction chamber will be under vacuum, so it will be harder to open than normal.
3. Remove the herb tube from the extraction chamber and place it in the tube holder. The peg in the bottom of the tube holder will press the valve ball up, allowing the remaining IPA to drain from the tube into the holder.
4. Leave the tube to drain for 15 minutes.
5. Empty the tube holder into a container with an airtight lid. Store the collected IPA for later distillation.
6. Replace the tube in the empty holder.
7. After 30-60 minutes, empty the last IPA into the container.

If you want to use the IPA to increase your yield, section 15.2.2, do not let the tube 'drip' for more than 15 minutes. After 15 minutes the IPA will only contain unwanted compounds, ie. chlorophylls, wax etc.

15.2.2 Add recovered IPA to increase the yield

If you extract high-quality herbs, the IPA recovered from the herb tube contains useful amounts of cannabinoids. By following this procedure, you can increase the yield, typically by 5-10%. The quality of the finished product will be slightly lower, and there will be slightly more chlorophylls present due to the longer IPA/herb exposure time.

Here is how to add the recovered IPA to the yield:

1. Recover the IPA from the herb tube as described earlier in section 15.2.1.
2. When distillation has reached the point where you can see the surface of the boiling IPA in the collection glass, press the pause button on the user panel.
3. Open the distillation chamber lid. BE CAREFUL! The distiller will be under a vacuum and contain hot, steaming IPA.

4. Add the recovered IPA from the herb tube to the IPA in the distillation chamber. Make sure no plant material from the recovered IPA finds its way into the distillation chamber.
5. Make sure the top gasket is in place, and close the distillation chamber lid.
6. Press the start button to continue the distillation.

15.2.3 Multiple, cumulative extractions

When extracting low-quality herbs, typically industrial hemp for CBD oils, the yield can be less than 1 gram. In some cases, you want to accumulate a bigger portion of raw extract in the same collection glass. This can be done by performing cumulative extractions.

Here is how:

1. Perform the first extraction as usual.
2. When the distillation is done leave the collection glass and extract in place.
3. Clean and refill the herb tube with fresh herbs.
4. Load the herb tube and check there is a sufficient amount of IPA for extraction in the tank (min 350 ml).
5. Perform the next extraction. The IPA and extract will be added to the first extract in the collection glass.
6. Repeat the process if needed.
7. Let the last extraction run to the end. The cumulative yield from the extractions will be present in the collection glass.

16. DISPOSAL OF MERLIN400

Merlin400 contains both plastic and electronic parts. If you need to discard your Merlin400 or parts of it, please follow these guidelines to make sure components are recycled properly. You can either disassemble the device and hand it over to a recycling plant or return it to Drizzle for recycling.

16.1 Disassemble and recycle parts

Please use a Tx8, Tx10 and Tx20 screwdriver to remove all visible screws and separate the components. The main component of Merlin400 are described here:

Electronics & motors

Merlin400 has four printed circuit boards, a motor, a power supply, and two cables. Unscrew all the electronic components and hand them in as electronic waste.

Plastic parts

The plastic parts of Merlin400 are made of PETG. If you can hand it in as PET or PETG waste, please do so. Otherwise, simply recycle it as hard plastic.

Top and bottom plate

The black top and bottom plate are made of acrylic plastic. Remove the plates with force (they are glued in place). If you can recycle it as acrylic, please do so. Otherwise, simply recycle it as plastic.

Tubing

The transparent tubes are made of silicone rubber. They can be recycled preferably as silicone. Otherwise, please recycle them as plastic.

16.2 Return to Drizzle

If you do not have the means of taking apart your Merlin400, you can ship it to Drizzle headquarters in Denmark. We will make sure to recycle the components in an environmentally responsible way. You can find the address on our webpage.

17. CONTACT

Drizzle ApS

Stamholmen 99
2650 Hvidovre
Denmark

Tel: +45 70 60 53 06

Email: contact@drizzle.life



Technical Specification

Dimensions (DxWxH): 210 x 210 x 235 mm
Weight: 2,5 kg
Voltage: 100-240VAC, 50/60 Hz
Power consumption: 100 W (max)

Ambient temperature range: 0 - 35 degrees C
Ambient altitude range / pressure: Up to 4000 m above sea level (> 600 mbar)

Solvent for extraction: 99,9% IPA (isopropanol)

Consumption pr extraction

Herbs: 20 - 45 grams, depending on type
Solvent (IPA): 75 - 125 ml depending on herb type and extraction settings
Time: 1,5 - 4 hours depending on herb type and extraction settings

Features

Fully automated extraction
Vacuum-distillation
Closed-loop recycling of solvent
Decarboxylation
Heating for handling
App to use Merlin400 via your phone
Future-proof through software updates

The appliance complies with the following Community directives:

"Low Voltage Directive" 2014/35/EC and subsequent amendments
"EMC Directive" 2014/30/EC and subsequent amendments
"RoHS Directive" 2011/65/EC
"Power Management" 1275/2008/EC
"WEEE" 2002/96/EC

The materials and items intended to come into contact with food are in accordance with the requirements of European legislation 1935/2004/EC and 10/2011/EC

